

Cell Reports, Volume 9

Supplemental Information

**Hand2 Is an Essential Regulator  
for Two Notch-Dependent Functions  
within the Embryonic Endocardium**

**Nathan J. VanDusen, Jose Casanovas, Joshua W. Vincentz, Beth A. Firulli, Marco Osterwalder, Javier Lopez-Rios, Rolf Zeller, Bin Zhou, Joaquim Grego-Bessa, José Luis De La Pompa, Weinian Shou, and Anthony B. Firulli**

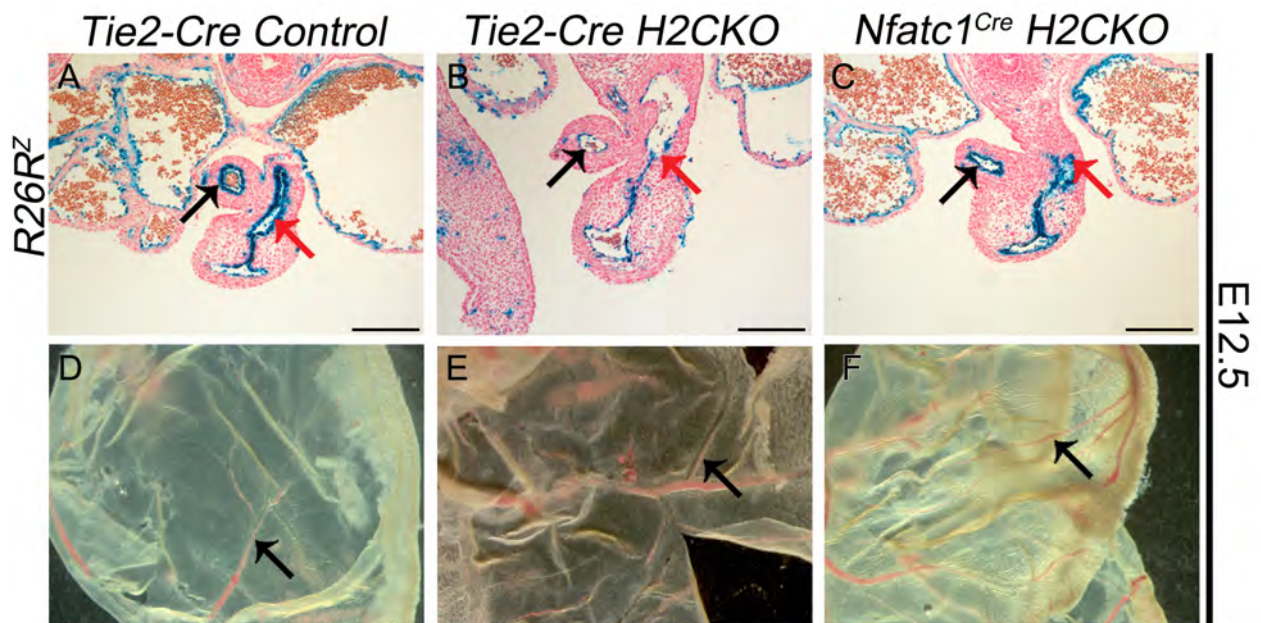

**Supplemental Figure 1: Development of the yolk sac vasculature and septation of the OFT occurs normally in *H2CKOs*. Data augments in Figure 1 and 2 showing cardiovascular domains where *Hand2* deletion does not show a phenotype.**

*H2CKOs* do not exhibit persistent truncus arteriosus (A-C), which has been reported in other conditional *Hand2* loss of function models (Tsuchihashi et al., 2011). Black arrows denote aorta; red arrows denote pulmonary trunk. *H2CKOs* lack yolk sac vasculature defects (D-F) which have been reported in systemic *Hand2* knock outs. Black arrows denote large yolk sac vessels. Scale bars in A-C represent 250 $\mu$ m.

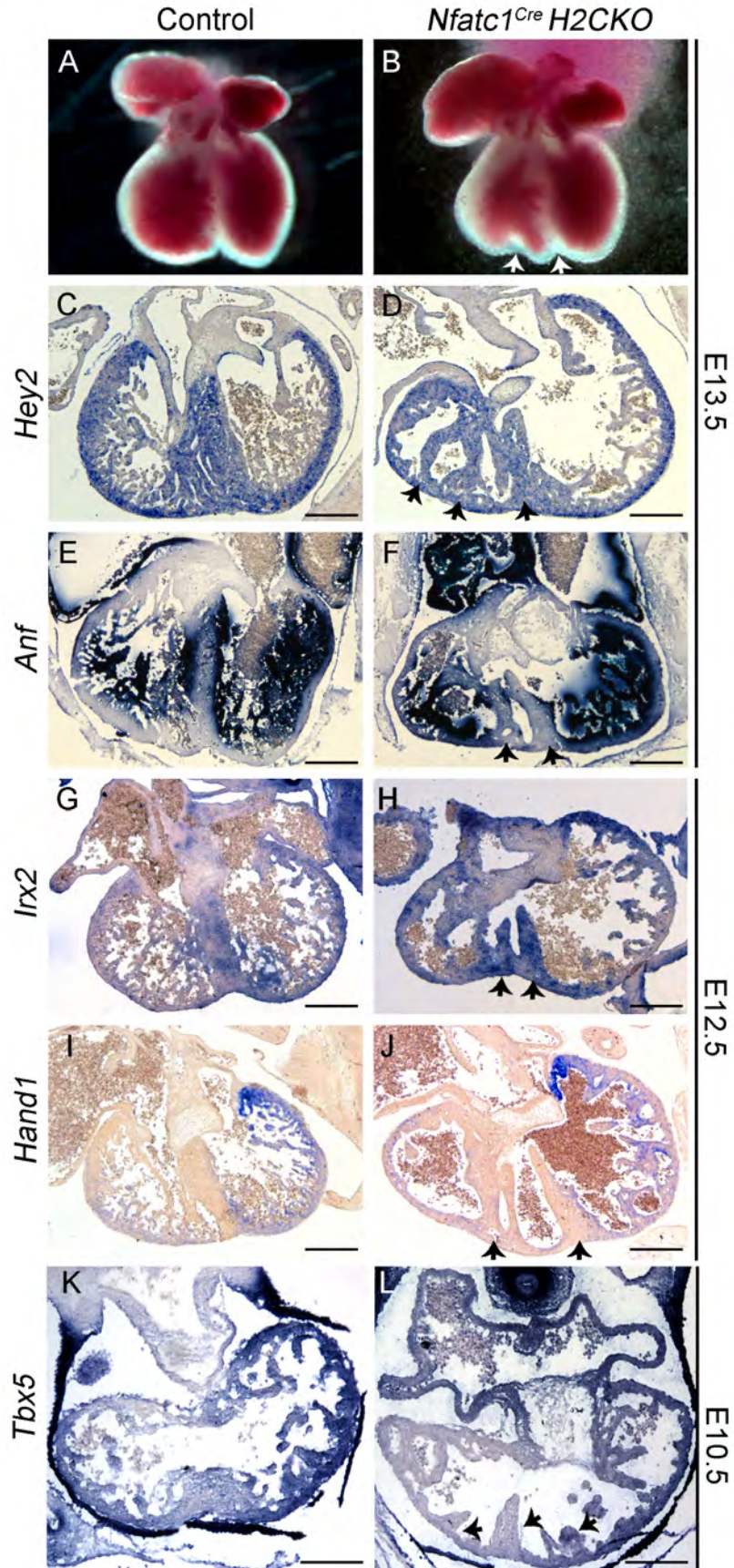

**Supplemental Figure 2. A subset of *Nfatc1<sup>Cre</sup>* *H2CKOs* displays multiple septums, which are marked by *Hey2* and *Irx2*, while excluding *Anf*. Data augments in Figure 1, detailing the molecular expression of IVS related genes within *H2CKOs*.**

Wholemount images of E13.5 control and *Nfatc1<sup>Cre</sup>* *H2CKO* hearts (A-B). *Hey2* section ISH of control and *Nfatc1<sup>Cre</sup>* *H2CKO* at E13.5 (C-D). *Anf* section ISH of control and *Nfatc1<sup>Cre</sup>* *H2CKO* at E13.5 (E-F). *Irx2* section ISH of control and *Nfatc1<sup>Cre</sup>* *H2CKO* at E12.5 (G-H). Arrowheads denote ectopic septal tissue. *Hand1* section ISH of control and *Nfatc1<sup>Cre</sup>* *H2CKO* at E13.5 (I-J). Right-most arrowhead shows normal *Hand1* expression within the left-most septa and left arrowhead denotes the lack of *Hand1* within the right ventricle ectopic septa. *Tbx5* section ISH of control and *Nfatc1<sup>Cre</sup>* *H2CKO* at E10.5 (K-L). Right-most arrowhead shows normal *Tbx5* expression within the left-most septa and left arrowheads denote the lack of *Tbx5* expression within the right ventricle ectopic septa. Scale bars in A-J represent 250 $\mu$ m; bars in K and L represent 200 $\mu$ m.

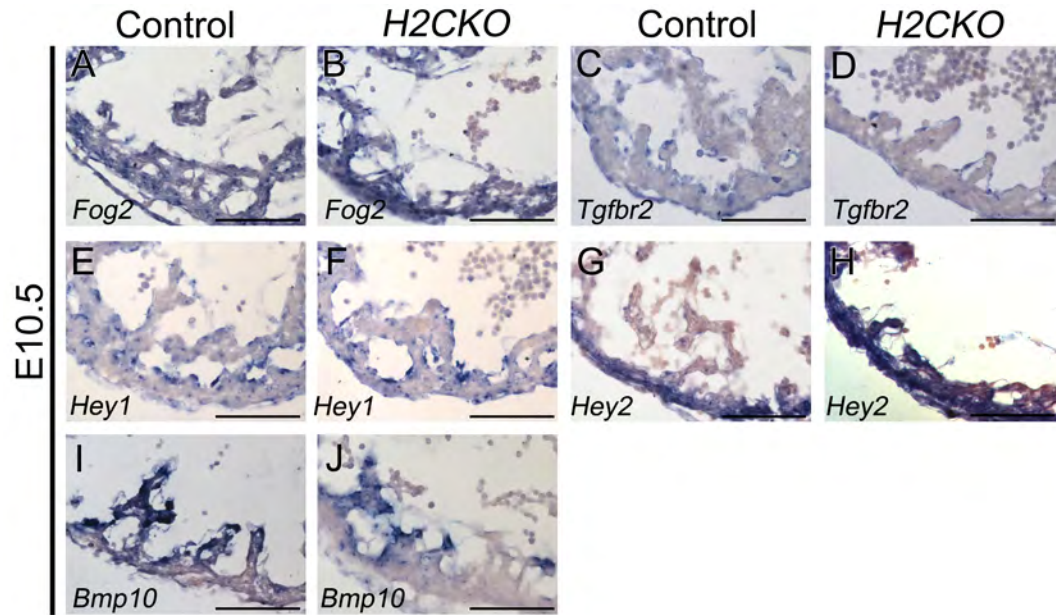

**Supplemental Figure 3. ISH analysis of TA and *Notch1* related marker expression in *Tie2-Cre H2CKOs* at E10.5. Data augments Figures 2 providing expression data on genes of interest that do not change in *H2CKOs*.**

Unchanged expression of *Fog2* and *TgfβR2* in *H2CKOs* indicates that endocardial loss of *Hand2* function is a novel cause of TA (A-D). Unchanged expression of Notch1 targets *Hey1* (E, F) and *Hey2* (G, H) is unaffected in *H2CKOs*. Myocardial *Bmp10* expression is not altered at E10.5 in *H2CKOs* (I, J). Scale bars represent 100μm.

A

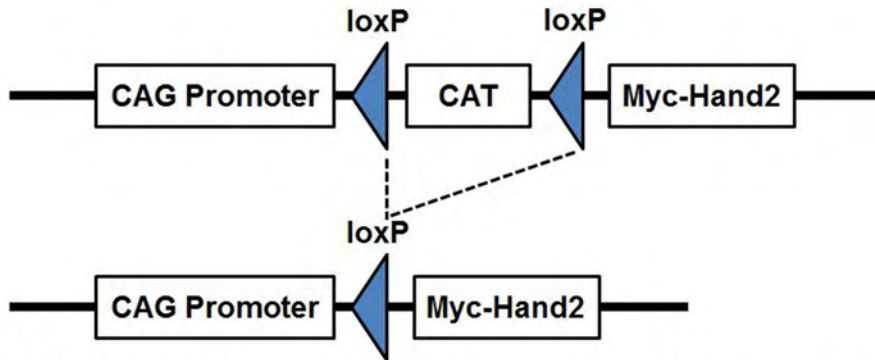

*Prx-Cre(+); CC-H2(+)*



*Nfatc1<sup>Cre</sup>; CC-H2(+)*

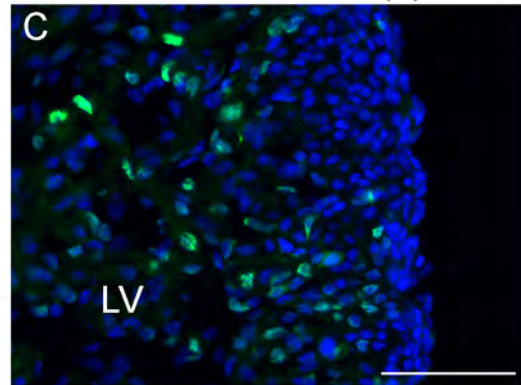

**Supplemental Figure 4. Construction and validation of *CAG-CAT-Hand2* (*CC-H2*) allele. Data augments Figure 5, demonstrating that the *CC-H2* transgene provides gain of function Hand2 in a Cre-dependent fashion.**

Schematic of *CC-H2* transgenic allele (A). Activation of *CC-H2* with Prx1-Cre results in an expected preaxial polydactyly (McFadden et al., 2002). Digits are numbered (B). Transverse section of E14.5 *Nfatc1<sup>Cre</sup>; CC-H2(+)* heart. αMyc immunohistochemistry (green) marks *Myc-Hand2* expressing endocardial cells containing the activated transgene (C). Scale bar in C represents 50μm.

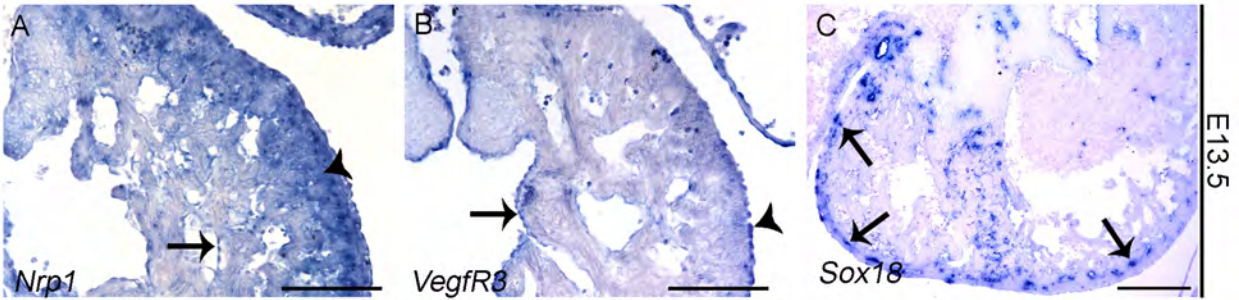

**Supplemental Figure 5. Cardiac expression of vascular genes at E13.5. Data provides support for data in Figure 7, showing expression of *Nrp1*, *VegfR3* and *Sox18* within cardiac endothelial populations.**

ISH reveals *Nrp1* expression within endocardium (arrow), as well as the ventricular myocardium (arrow head; A). *VegfR3* ISH demonstrates expression within the endocardium (arrow) and epicardium (arrow head; B). *Sox18* ISH reveals expression within endothelium of the coronary vasculature (arrows), but not within ventricular endocardium (C). Scale bars in A and B represent 100 $\mu$ m; bar in C represents 250 $\mu$ m.

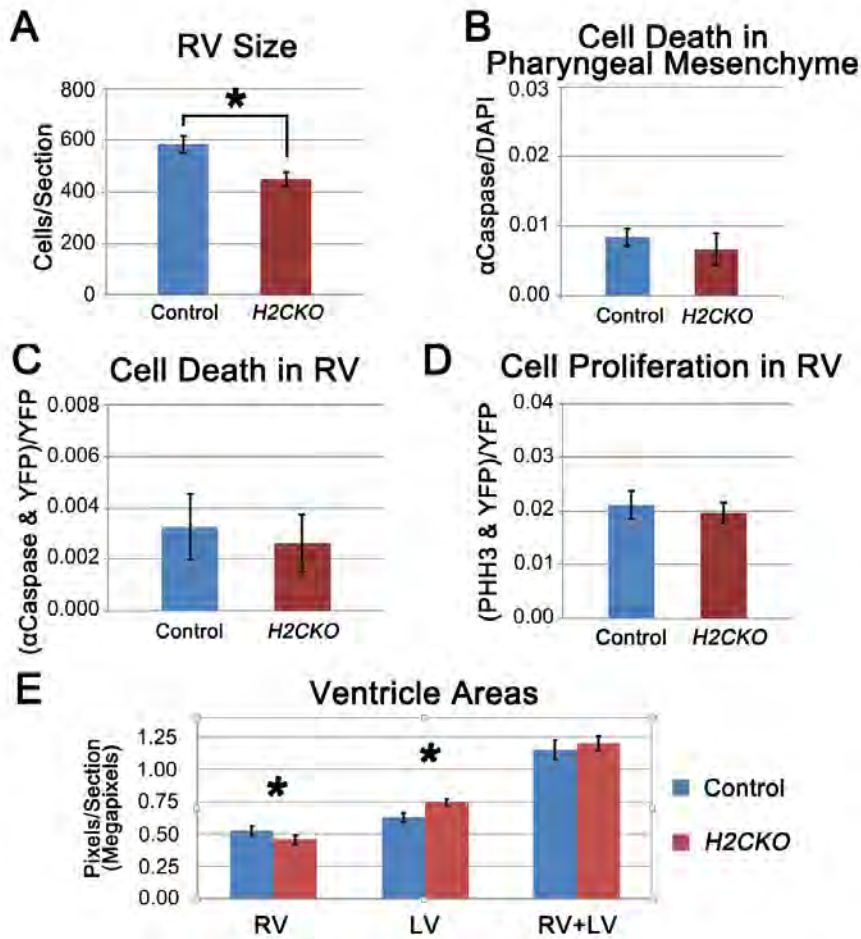

**Supplemental Figure 6: *H2CKOs* exhibit a hypoplastic RV and larger LV, but do not show significant differences in cell death or proliferation. Data augments Figure 1 and discussion of the tricuspid atresia phenotype observed in *H2CKOs* with measurement of ventricle size, cell death and cell proliferation.**

Hypoplastic RV at E10.5 in *Tie2-Cre H2CKOs* was confirmed by counting DAPI(+) RV nuclei (A). Cell death in control and *Tie2-Cre H2CKO* E9.5 pharyngeal mesoderm was measured by quantification of active-Caspase-3(+) cells. No significant difference was detected (B). Cell death was measured in control and *Tie2-Cre H2CKO* E10.5 RV by

quantification of active-Caspase-3(+) cells relative to the number of Cre lineage GFP(+) cells. No significant difference was detected (C). Cell proliferation in the E10.5 RV was determined by counting PHH3(+) cells and Cre lineage GFP(+) cells. No significant difference was detected between control and *H2CKO* hearts (D). Ventricle area measurements obtained by measuring ventricle areas in comparable sections revealed a smaller RV and larger LV in *Tie2-Cre H2CKOs* (E).

	E10.5	E12.5	E14.5	Postnatal
Total	199	75	53	58
Cre(+)	98	38	20	26
Mutants	38 (41)	18 (16)	2 (9)	0 (11)

**Supplemental Table1. Genotypic frequencies of embryos obtained from ♂*Tie2-Cre*; *H2*<sup>+/-</sup> x ♀*Hand2*<sup>fx/fx</sup>; *R26R*<sup>Z/Z</sup> intercrosses. Data augments Figure 1.**

Expected number in parentheses.

	TA	DILV	Malformed Septum	Hypo-Trabeculation	Hypoplastic RV	Multiple Septums	Hyper-Vascularization
<i>Tie2-Cre H2CKO</i>	11/14	3/14	14/14	14/14	11/14	2/14	(5/7)
<i>Nfatc1</i> <sup>Cre</sup> <i>H2CKO</i>	9/15	1/15	14/15	15/15	10/15	8/15	(6/7)

**Supplemental Table 2. Phenotype Penetrance in E12.5 and E13.5 *H2CKOs* Data augments the data presented in Figure 1, defining penetrance of the observed phenotypes.**

<b>Term</b>	<b>Definition</b>
Endothelium	A single cell layer that lines various cavities of the body, particularly blood vessels. Marked by the <i>Tie2-Cre</i> lineage.
Ventricular Endocardium	The subset of endothelial cells which line the ventricular chambers. Marked by the <i>Tie2-Cre</i> and <i>Nfatc1<sup>Cre</sup></i> lineages.
Coronary Endothelium	The subset of endothelial cells which line coronary arteries. Completely marked by the <i>Tie2-Cre</i> lineage, partially marked by the <i>Nfatc1<sup>Cre</sup></i> lineage.
Cardiac Endothelium	All endothelial cells found within the heart, including ventricular endocardium and coronary endothelium. Often simply referred to as endocardium. Completely marked by <i>Tie2-Cre</i> lineage, mostly marked by the <i>Nfatc1<sup>Cre</sup></i> lineage.

**Supplemental Table 3. Glossary of terms Table 3 provides definitions of the various forms of endothelium discussed in the manuscript.**

	<b>Genomic Location (NCBI37/mm9)</b>	<b>Fold Enrichment</b>	<b>Distance from Nrg1 Start</b>
Dll4	chr2:119130554-119131353	47	-21kb
Nrp1	chr8:130526263-130526825	45	-356kb
Couptfll Peak 1	chr7:78208195-78208512	28	-703kb
Couptfll Peak 2	chr7:78046948-78047713	37	-542kb
Couptfll Peak 3	chr7:77957671-77959071	92	-453kb
Couptfll Peak 4	chr7:77249235-77250369	81	+256kb
Couptfll Peak 5	chr7:77212727-77213852	41	+292kb

**Supplemental Table 4. ChIP-Seq data showing Hand2 binding sites adjacent to vascular related genes differentially expressed in *Nfatc1<sup>Cre</sup>* H2CKOs. Data augments discussion and ChIP-seq data presented in Figure 7.**

## **Supplemental Procedures: expands the experimental procedures**

### **Histology**

Histology and X-gal staining were conducted essentially as previously described for paraffin embedded embryos (Vincentz et al., 2008). For X-gal staining, embryos were dissected in PBS, fixed in 2% PFA plus 0.2% glutaraldehyde for 20 minutes, rinsed in PBS, and incubated in X-gal staining solution overnight. Embryos were then post-fixed with 4% PFA for one hour, rinsed, and dehydrated through a graded series of ethanol dilutions, with 10 minutes in each dilution (50%, 70%, 90%, 95%, and 100% ethanol). Dehydrated embryos were incubated in a 1:1 citrosolv ethanol solution for 10 minutes, rinsed with 100% citrosolv twice for 10 minutes each, and embedded in paraffin for sectioning. Sections were counterstained with nuclear fast red. For alcian blue staining, embryos were dissected in PBS, fixed in 4% PFA for one hour, rinsed with PBT, and dehydrated through a graded series of methanol dilutions (25%, 50%, 75%, 100%) for 10 minutes in each dilution. Dehydrated embryos were rinsed in a 1:1 xylene methanol solution for 10 minutes, cleared with 100% xylene, and embedded in paraffin. Paraffin was removed from sections using citrosolv. Sections were rehydrated, and stained with 0.15mg/ml Alcian Blue in 5% glacial acetic acid for 30 minutes. Stained sections were rinsed with H<sub>2</sub>O, counterstained with nuclear fast red, and dehydrated with ethanol. Dehydrated sections were incubated in citrosolv for 15 minutes, and cover-slipped.

### **Ventricle Area Measurements**

Comparative Hand1 ISH transverse sections were collected from somite matched E10.5 control and *H2CKO* embryos. Ventricular areas from four sections from each of three

E10.5 *H2CKO* embryos, and matched control sections were measured. Hearts were divided into individual ventricles based on septal position and expression of the LV marker Hand1. Areas of individual ventricles were measured using Adobe Photoshop.

### **Immunohistochemistry and Cell Counting**

Embryos were fixed in 2% PFA overnight, infused with 30% sucrose, cryoprotected, and sectioned at 10um. Frozen sections were washed in PBS, blocked in 1.5% normal serum for one hour, and incubated with primary antibody overnight at 4°C. Secondary antibodies were conjugated with Alexa 488 or 594 (Molecular probes), and were used at a dilution of 1:500. Images were collected on a Leica CTR 5000 microscope at standardized conditions with Leica Application Suite software. Cell-autonomous proliferation/death was calculated by counting cells displaying co-localization of GFP (Cre lineage) and pHistone H3/aCaspase, divided by total number of GFP(+) cells. Non cell-autonomous proliferation/death was calculated by counting all cells displaying pHistone H3/aCaspase expression, divided by total number of GFP(+) cells. 20 pairs of comparative RV sections were utilized for both pHistone H3 and aCaspase cell counts. For RV size analysis, two *Tie2-Cre H2CKO* mutant and two control littermates were collected at E10.5, and direct RV cell counts using DAPI stained nuclei were performed. DAPI(+) nuclei from every sixth section of the RV (12 sections per heart) were counted.

<b>Antibody</b>	<b>Manufacturer</b>	<b>Dilution</b>
Phospho-Histone H3	Abcam 47297	1:500
Activated-Caspase 3	Promega G748A	1:500
GFP	Aves 1020	1:500
VegfR2	Abcam 10972	1:50
c-Myc	Sigma C3956	1:200
Lyve-1	Abcam 14917	1:200

## Genotyping

Genotyping of adult mice was achieved by southern blot on tail genomic DNA, or by PCR for embryos. Genotyping for *Cre*, *Hand2<sup>flox</sup>*, *Hand2 systemic*, *EphrinB2<sup>flox</sup>*, and *Rosa* alleles was conducted as previously described (Barnes et al., 2011; Gerety and Anderson, 2002). Genotyping of adult CAG-CAT-*Hand2* mice was conducted by southern blot using BamHI digested genomic DNA and a *Hand2* cDNA probe. Genotyping for CAG-CAT-*Hand2*(+) embryos was conducted by PCR using oligo Hand2-CC(F) and SV40PA(R). These primers were used with a denaturing temperature of 95°C for 30 seconds, annealing temperature of 55°C for 60 seconds, and extension at 72°C for 60 seconds, for 35 cycles.

## Oligos for EMSA, ChIP, genotyping, and cloning Supplemental Procedures

augments the experimental procedures within the primary manuscript.

Bold type signifies E/D-box or corresponding mutagenized region.

Oligo	Application	Sequence (5' → 3')
Nrg1.D1	EMSA	GCGAAGGAGGG <b>CGCCTG</b> CGTCCAAC
Nrg1.D1m	EMSA	GCGAAGGAGGG <b>CACTG</b> CGTCCAAC
Nrg1.E2	EMSA	AACTTGCGGG <b>CAATTG</b> AAAAAGAGC
Nrg1.E2m	EMSA	AACTTGCGGG <b>GCATTG</b> AAAAAGAGC
Nrg1.E3	EMSA	GCAGCGGCGGG <b>CAGCTG</b> CCGGGAGAT
Nrg1.E3m	EMSA	GCAGCGGCGGG <b>CACTG</b> CCGGGAGAT
VegfR3.D1	EMSA	TCTGCAGGG <b>CGCTTG</b> GCTAAGATT
VegfR3.D1m	EMSA	TCTGCAGGG <b>GTCTTG</b> GCTAAGATT
VegfR3.E2	EMSA	CAGTGCAGT <b>CACCTG</b> CACTCCTCGC
VegfR3.E2m	EMSA	CAGTGCAGT <b>GTCTG</b> CACTCCTCGC
Nrg1-426F	ChIP	GAGTTCCCCGAACTTGTTG
Nrg1-324R	ChIP	AGGTTATCACCGTCCTGCTC
GAPDH(F)	ChIP	CTGCACCACCAACTGCTTAG
GAPDH(R)	ChIP	CAGTGAGCTTCCCGTTCAG
VegfR3(-459)F	ChIP	CTGGGTCTCCCTATGTTACG
VegfR3(-175)R	ChIP	GGCGTCCGGTGCACCCGAGC
Hand2-CC(F)	Genotyping	GGGATCCATCTGCCCAAGGACGACCAG
SV40PA(R)	Genotyping	GAAATTTGTGATGCTATTGC

Nrp1(-358/-355kb)F	Cloning	CCTACCTCCTGTCATGCCTC
Nrp1(-358/-355kb)R	Cloning	GGTGAGTATGTCAGCAGACTC
Dll4(-23/-20kb)F	Cloning	GAAAGAGGCTTGCTTGGGAAGG
Dll4(-23/-20kb)R	Cloning	CTACCATATTGTACTIONACCGG
Nrg1.1000F	Cloning	AACTTCCCTAAAGCAAGAG
Nrg1.500F	Cloning	GTGTGGTGGGGAAAGAGGG
Nrg1.1R	Cloning	CTCGCTAAAGATGAGCGCT
Nrg1.250R	Cloning	GCTCCGGTGGCTGTCTCGCT
VegfR3.1R	Cloning	CTCCGGCCCCTGGGCGCGGGTGG
VegR3.500F	Cloning	ACACTATAGAGAGATCTGGCTTCTGC

Supplemental Procedures augments the experimental procedures within the primary manuscript by providing important details such as antibody identification and primer sequences.